

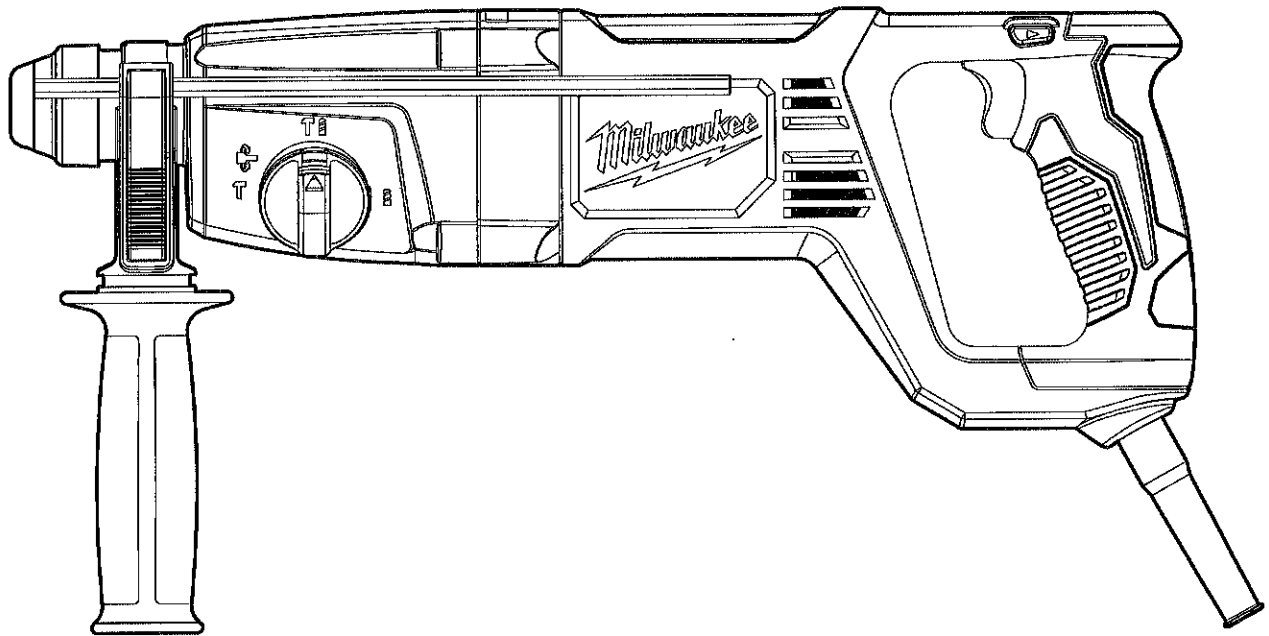



OPERATOR'S MANUAL
MANUEL de L'UTILISATEUR
MANUAL del OPERADOR



Cat. No. / No de cat.

5262-21 

1" SDS PLUS ROTARY HAMMER
MARTEAU ROTATIF 25 mm (1")
25 mm (1") ROTOMARTILLOS



WARNING To reduce the risk of injury, user must read and understand operator's manual.

AVERTISSEMENT Afin de réduire le risque de blessures, l'utilisateur doit lire et bien comprendre le manuel.

ADVERTENCIA Para reducir el riesgo de lesiones, el usuario debe leer y entender el manual.

GENERAL POWER TOOL SAFETY WARNINGS

WARNING Read all safety warnings, instructions, illustrations and specifications provided with this power tool. Failure to follow all instructions listed below may result in electric shock, fire and/or serious injury. **Save all warnings and instructions for future reference.** The term "power tool" in the warnings refers to your mains-operated (corded) power tool or battery-operated (cordless) power tool.

WORK AREA SAFETY

- **Keep work area clean and well lit.** Cluttered or dark areas invite accidents.
- **Do not operate power tools in explosive atmospheres, such as in the presence of flammable liquids, gases or dust.** Power tools create sparks which may ignite the dust or fumes.
- **Keep children and bystanders away while operating a power tool.** Distractions can cause you to lose control.

ELECTRICAL SAFETY

- **Power tool plugs must match the outlet. Never modify the plug in any way. Do not use any adapter plugs with earthed (grounded) power tools.** Unmodified plugs and matching outlets will reduce risk of electric shock.
- **Avoid body contact with earthed or grounded surfaces, such as pipes, radiators, ranges and refrigerators.** There is an increased risk of electric shock if your body is earthed or grounded.
- **Do not expose power tools to rain or wet conditions.** Water entering a power tool will increase the risk of electric shock.
- **Do not abuse the cord. Never use the cord for carrying, pulling or unplugging the power tool. Keep cord away from heat, oil, sharp edges or moving parts.** Damaged or entangled cords increase the risk of electric shock.
- **When operating a power tool outdoors, use an extension cord suitable for outdoor use.** Use of a cord suitable for outdoor use reduces the risk of electric shock.
- **If operating a power tool in a damp location is unavoidable, use a ground fault circuit interrupter (GFCI) protected supply.** Use of an GFCI reduces the risk of electric shock.

PERSONAL SAFETY

- **Stay alert, watch what you are doing and use common sense when operating a power tool. Do not use a power tool while you are tired or under the influence of drugs, alcohol or medication.** A moment of inattention while operating power tools may result in serious personal injury.
- **Use personal protective equipment. Always wear eye protection.** Protective equipment such as a dust mask, non-skid safety shoes, hard hat or hearing protection used for appropriate conditions will reduce personal injuries.
- **Prevent unintentional starting. Ensure the switch is in the off-position before connecting to power source and/or battery pack, picking up or carrying the tool.** Carrying power tools with your finger on the switch or energizing power tools that have the switch on invites accidents.
- **Remove any adjusting key or wrench before turning the power tool on.** A wrench or a key left attached to a rotating part of the power tool may result in personal injury.
- **Do not overreach. Keep proper footing and balance at all times.** This enables better control of the power tool in unexpected situations.

- **Dress properly. Do not wear loose clothing or jewelry. Keep your hair and clothing away from moving parts.** Loose clothes, jewelry or long hair can be caught in moving parts.
- **If devices are provided for the connection of dust extraction and collection facilities, ensure these are connected and properly used.** Use of dust collection can reduce dust-related hazards.
- **Do not let familiarity gained from frequent use of tools allow you to become complacent and ignore tool safety principles.** A careless action can cause severe injury within a fraction of a second.

POWER TOOL USE AND CARE

- **Do not force the power tool. Use the correct power tool for your application.** The correct power tool will do the job better and safer at the rate for which it was designed.
- **Do not use the power tool if the switch does not turn it on and off.** Any power tool that cannot be controlled with the switch is dangerous and must be repaired.
- **Disconnect the plug from the power source and/or remove the battery pack, if detachable, from the power tool before making any adjustments, changing accessories, or storing power tools.** Such preventive safety measures reduce the risk of starting the power tool accidentally.
- **Store idle power tools out of the reach of children and do not allow persons unfamiliar with the power tool or these instructions to operate the power tool.** Power tools are dangerous in the hands of untrained users.
- **Maintain power tools and accessories. Check for misalignment or binding of moving parts, breakage of parts and any other condition that may affect the power tool's operation. If damaged, have the power tool repaired before use.** Many accidents are caused by poorly maintained power tools.
- **Keep cutting tools sharp and clean.** Properly maintained cutting tools with sharp cutting edges are less likely to bind and are easier to control.
- **Use the power tool, accessories and tool bits etc. in accordance with these instructions, taking into account the working conditions and the work to be performed.** Use of the power tool for operations different from those intended could result in a hazardous situation.
- **Keep handles and grasping surfaces dry, clean and free from oil and grease.** Slippery handles and grasping surfaces do not allow for safe handling and control of the tool in unexpected situations.

SERVICE

- **Have your power tool serviced by a qualified repair person using only identical replacement parts.** This will ensure that the safety of the power tool is maintained.

SPECIFIC SAFETY RULES FOR ROTARY HAMMER

- **Wear ear protectors.** Exposure to noise can cause hearing loss.
- **Use auxiliary handle(s), if supplied with the tool.** Loss of control can cause personal injury.
- **Hold power tool by insulated gripping surfaces, when performing an operation where the cutting accessory may contact hidden wiring or its own cord.** Cutting accessory contacting a "live" wire may make exposed metal parts of the power tool "live" and could give the operator an electric shock.
- **Keep hands away from all cutting edges and moving parts.**
- **WARNING** To reduce the risk of injury, wear a dust mask or use an OSHA compliant dust extraction solution when working in dusty situations. Dust particles can harm your lungs.

- **Maintain labels and nameplates.** These carry important information. If unreadable or missing, contact a MILWAUKEE service facility for a free replacement.
- **WARNING** Some dust created by power sanding, sawing, grinding, drilling, and other construction activities contains chemicals known to cause cancer, birth defects or other reproductive harm. Some examples of these chemicals are:
 - lead from lead-based paint
 - crystalline silica from bricks and cement and other masonry products, and
 - arsenic and chromium from chemically-treated lumber.
 Your risk from these exposures varies, depending on how often you do this type of work. To reduce your exposure to these chemicals: work in a well ventilated area, and work with approved safety equipment, such as those dust masks that are specially designed to filter out microscopic particles.

EXTENSION CORDS

Grounded tools require a three wire extension cord. Double insulated tools can use either a two or three wire extension cord. As the distance from the supply outlet increases, you must use a heavier gauge extension cord. Using extension cords with inadequately sized wire causes a serious drop in voltage, resulting in loss of power and possible tool damage. Refer to the table shown to determine the required minimum wire size.

The smaller the gauge number of the wire, the greater the capacity of the cord. For example, a 14 gauge cord can carry a higher current than a 16 gauge cord. When using more than one extension cord to make up the total length, be sure each cord contains at least the minimum wire size required. If you are using one extension cord for more than one tool, add the nameplate amperes and use the sum to determine the required minimum wire size.

Guidelines for Using Extension Cords

- If you are using an extension cord outdoors, be sure it is marked with the suffix "W-A" ("W" in Canada) to indicate that it is acceptable for outdoor use.
- Be sure your extension cord is properly wired and in good electrical condition. Always replace a damaged extension cord or have it repaired by a qualified person before using it.
- Protect your extension cords from sharp objects, excessive heat and damp or wet areas.

| Recommended Minimum Wire Gauge For Extension Cords* | | | | | |
|---|-----------------------|-----|-----|------|------|
| Nameplate Amps | Extension Cord Length | | | | |
| | 25' | 50' | 75' | 100' | 150' |
| 0 - 2.0 | 18 | 18 | 18 | 18 | 16 |
| 2.1 - 3.4 | 18 | 18 | 18 | 16 | 14 |
| 3.5 - 5.0 | 18 | 18 | 16 | 14 | 12 |
| 5.1 - 7.0 | 18 | 16 | 14 | 12 | 12 |
| 7.1 - 12.0 | 16 | 14 | 12 | 10 | -- |
| 12.1 - 16.0 | 14 | 12 | 10 | -- | -- |
| 16.1 - 20.0 | 12 | 10 | -- | -- | -- |

* Based on limiting the line voltage drop to five volts at 150% of the rated amperes.

GROUNDING

WARNING Improperly connecting the grounding wire can result in the risk of electric shock. Check with a qualified electrician if you are in doubt as to whether the outlet is properly grounded. Do not modify the plug provided with the tool. Never remove the grounding prong from the plug. Do not use the tool if the

cord or plug is damaged. If damaged, have it repaired by a MILWAUKEE service facility before use. If the plug will not fit the outlet, have a proper outlet installed by a qualified electrician.

Grounded Tools (Three-Prong Plugs)

Tools marked "Grounding Required" have a three wire cord and three prong grounding plug. The plug must be connected to a properly grounded outlet (See Figure A). If the tool should electrically malfunction or break down, grounding provides a low resistance path to carry electricity away from the user, reducing the risk of electric shock.

The grounding prong in the plug is connected through the green wire inside the cord to the grounding system in the tool. The green wire in the cord must be the only wire connected to the tool's grounding system and must never be attached to an electrically "live" terminal.

Your tool must be plugged into an appropriate outlet, properly installed and grounded in accordance with all codes and ordinances. The plug and outlet should look like those in Figure A.

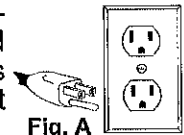

Fig. A

Double Insulated Tools (Two-Prong Plugs)

Tools marked "Double Insulated" do not require grounding. They have a special double insulation system which satisfies OSHA requirements and complies with the applicable standards of Underwriters Laboratories, Inc., the Canadian Standard Association and the National Electrical Code. Double Insulated tools may be used in either

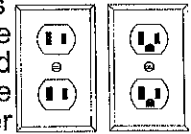

Fig. B Fig. C

SYMBOLOLOGY



Double Insulated



Volts



Alternating Current



Amps

n_0 XXXX min⁻¹ No Load Revolutions per Minute (RPM)



Blows per Minute Under Load (BPM)



UL Listing for Canada and U.S.



Approval Mark for Mexico

SPECIFICATIONS

| | |
|--|----------|
| Cat. No. | 5262-21 |
| Volts | 120 AC |
| Amps | 8 |
| No Load RPM | 0 - 1620 |
| No Load BPM | 0 - 5860 |
| Type | SDS Plus |
| Carbide Tipped Percussion Bit (concrete) | 1" |
| Thin Wall Percussion Core Bit (concrete) | 2-1/2" |
| Twist Drill Bit (Wood) (Drill only) | 1-1/8" |
| Twist Drill Bit (Steel) (Drill only) | 1/2" |

FUNCTIONAL DESCRIPTION

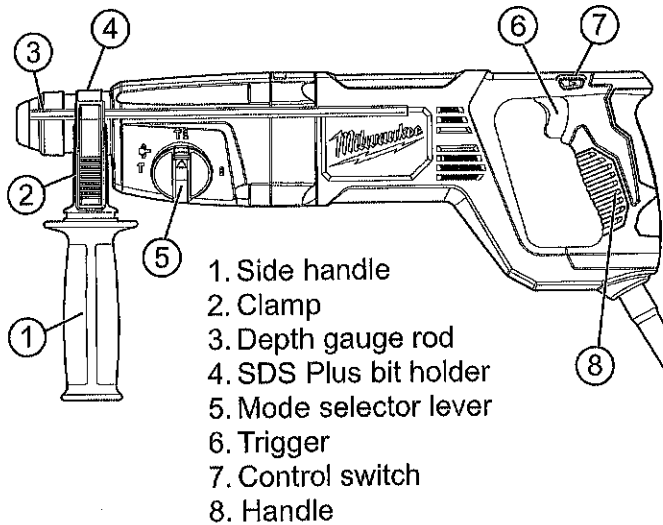

ASSEMBLY

WARNING To reduce the risk of injury, always unplug tool before changing or removing accessories. Only use accessories specifically recommended for this tool. Others may be hazardous.

To reduce the risk of injury, always use a side handle when using this tool. Always brace or hold securely.

Adjusting the Side Handle Position

1. Loosen the side handle by unscrewing the side handle grip until the side handle rotates freely.
2. Rotate the side handle to the desired position.
3. Tighten the side handle grip securely.

Setting the Depth Gauge

1. Press in the clamping lever.
2. Slide the depth gauge rod backward or forward until it is set for the desired depth.

NOTE: The drilling depth is the distance between the tip of the bit and the tip of the rod.

3. Release the clamping lever.

WARNING To reduce the risk of injury, do not grasp the bit while the chuck is rotating or while the bit is falling from the chuck.

Installing Drill Bits and Chisels

Only use accessories with SDS or SDS Plus shanks. Be sure that the shank of the bit is clean. Dirt particles may cause the bit to line up improperly. Do not use bits larger than the maximum recommended capacity of the drill because gear damage or motor overloading may result. For best performance, be sure that the bit is properly sharpened and the shank is lightly greased before use.

1. Insert the bit or chisel into the nose of the tool.
2. Rotate bit slowly until it aligns with the locking mechanism.
3. Push bit into tool until it locks.
4. Check that the bit is locked properly; it should be possible to pull the bit back and forth slightly (about 1/4").

5. To remove bits and chisels, pull bit holder release collar toward the rear of tool and remove bit.

NOTE: Use caution when handling hot bits and chisels.

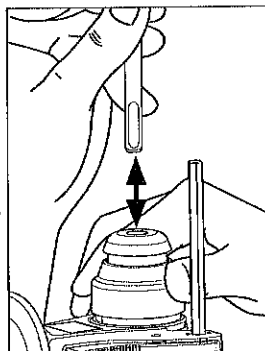

OPERATION

WARNING To reduce the risk of injury, always unplug tool before attaching or removing accessories or making adjustments. Use only specifically recommended accessories. Others may be hazardous.

To reduce the risk of injury, wear safety goggles or glasses with side shields.

To reduce the risk of injury, wear a dust mask or use an OSHA compliant dust extraction solution when working in dusty situations.

To reduce the risk of injury, keep hands and cord away from the bit and all moving parts.

To reduce the risk of injury, always use a side handle when using this tool. Always brace or hold securely.

Selecting Action

These MILWAUKEE Rotary Hammers have three settings: rotation only, rotary hammer, and hammer only. Always allow the motor to come to a complete stop before changing the mode selection to avoid damage to the tool.

1. For rotation only, press in the selector release button and turn the selector lever so the arrow on the lever points to the twist drill symbol.
2. For rotary hammering, press in the selector release button and turn the selector lever so the arrow points to the hammer and twist drill symbol.
3. For hammering only, press in the selector release button and turn the selector lever so the arrow points to the hammer symbol.
4. To freely rotate the bit to the desired angle for hammering only, press in the selector release button and turn the selector lever to the symbol. Then, follow step 3.

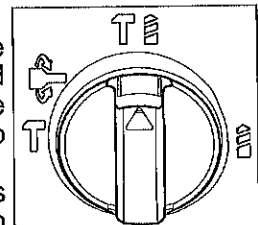

NOTE: To engage the hammering mechanism, maintain pressure on the bit. When pressure on the bit is released, the hammering action will stop.

Using the Control Switch

Always allow the motor to come to a complete stop before using the control switch.

For **forward** (clockwise) rotation, push the control switch to the left side of the tool. Check the direction of rotation before use.

For **reverse** (counterclockwise) rotation, push the control switch to the right side of the tool. Check direction of rotation before use.

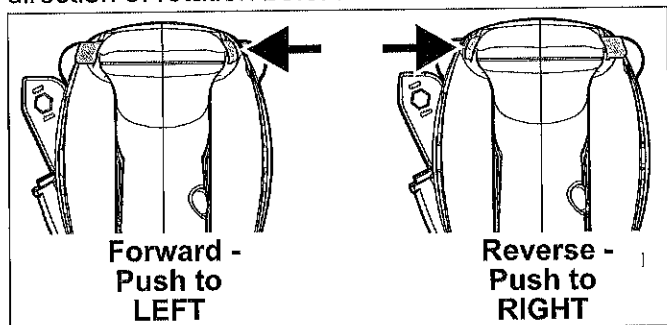

Starting, Stopping and Controlling Speed

1. To **start** the tool, grasp the handle firmly and pull the trigger.
2. To **vary** the speed, increase or decrease the pressure on the trigger. The further the trigger is pulled, the greater the speed.

3. To **stop** the tool, release the trigger. Make sure the tool comes to a complete stop before laying the tool down.

Operating

Position the tool, grasp the handles firmly and pull the trigger. Always hold the tool securely using both handles to maintain control. This tool has been designed to achieve top performance with only moderate pressure. Let the tool do the work.

If the speed begins to drop off when drilling large or deep holes, pull the bit partially out of the hole while the tool is running to help clear dust. Do not use water to settle the dust since it will clog the bit flutes and tend to make the bit bind in the hole. If the bit should bind, a built-in, non-adjustable slip clutch prevents the bit from turning. If this occurs, stop the tool, free the bit and begin again.

Using Rotary Percussion Core Bits

Core bits are useful for drilling larger holes for conduit and pipe. MILWAUKEE Thin Wall Core Bits have heat-treated steel bodies with durable carbide tips. These core bits are specially designed for fast, accurate drilling with combined hammering and rotary action.

1. Clean and lubricate the threads on the adapter and core bit to make later removal easier. Screw the threaded end of the adapter into the rear of the core bit.

NOTE: For core bits 1- 1/4" and larger, push the guide plate onto the pointed end of the center pin. Insert the center pin and guide plate assembly into the core bit. Be sure the small end of the center pin is securely placed into the hole in the center of the core bit.

2. Insert the adapter into the nose of the tool as described in "Installing Bits". Set the hammer/drill shift knob to hammering with rotation.
3. Press the center pin firmly against your center mark, hold the tool firmly and pull the trigger. **NOTE:** If a center pin and guide plate are not available, use a template or notched board to start the hole.

4. After drilling to about the depth of the core bit teeth, remove the center pin and guide plate from the core bit. Resume drilling.

5. To change the core bit, hold the tool upwards, pointing it away from your body, and run it briefly in forward to loosen the core bit from the adapter.

NOTE: To make holes deeper than 3", remove the core bit, break and remove the core. Resume drilling.

MAINTENANCE

WARNING To reduce the risk of injury, always unplug the tool before performing any maintenance. Never disassemble the tool. Contact a MILWAUKEE service facility for ALL repairs.

Maintaining Tools

Keep your tool in good repair by adopting a regular maintenance program. Inspect your tool for issues such as undue noise, misalignment or binding of moving parts, breakage of parts, or any other condi-

tion that may affect the tool operation. Return the tool to a MILWAUKEE service facility for repair. After six months to one year, depending on use, return the tool to a MILWAUKEE service facility for inspection.

WARNING To reduce the risk of personal injury, electric shock and damage, never immerse your tool in liquid or allow a liquid to flow inside it.

Cleaning

Clean dust and debris from vents. Keep handles clean, dry and free of oil or grease. Use only mild soap and a damp cloth to clean, since certain cleaning agents and solvents are harmful to plastics and other insulated parts. Some of these include gasoline, turpentine, lacquer thinner, paint thinner, chlorinated cleaning solvents, ammonia and household detergents containing ammonia. Never use flammable or combustible solvents around tools.

Repairs

For repairs, return the tool to the nearest service center.

ACCESSORIES

WARNING Use only recommended accessories. Others may be hazardous.

For a complete listing of accessories, go online to www.milwaukeetool.com or contact a distributor.

SERVICE - UNITED STATES

1-800-SAWDUST (1.800.729.3878)
Monday-Friday, 7:00 AM - 6:30 PM CST
or visit www.milwaukeetool.com

Contact Corporate After Sales Service Technical Support with technical, service/repair, or warranty questions.

Email: metproductsupport@milwaukeetool.com

Become a Heavy Duty Club Member at www.milwaukeetool.com to receive important notifications regarding your tool purchases.

SERVICE - CANADA

Milwaukee Tool (Canada) Ltd
1.800.268.4015
Monday-Friday, 7:00 AM - 4:30 PM CST
or visit www.milwaukeetool.ca

LIMITED WARRANTY USA & CANADA

Every MILWAUKEE power tool* (see exceptions below) is warranted to the original purchaser only to be free from defects in material and workmanship. Subject to certain exceptions, MILWAUKEE will repair or replace any part on an electric power tool which, after examination, is determined by MILWAUKEE to be defective in material or workmanship for a period of five (5) years** after the date of purchase unless otherwise noted. Return of the power tool to a MILWAUKEE factory Service Center location or MILWAUKEE Authorized Service Station, freight prepaid and insured, is required. A copy of the proof of purchase should be included with the return product. This warranty does not apply to damage that MILWAUKEE determines to be from repairs made or attempted by anyone other than MILWAUKEE authorized personnel, misuse, alterations, abuse, normal wear and tear, lack of maintenance, or accidents.

Normal Wear: Many power tools need periodic parts replacement and service to achieve best performance. This warranty does not cover repair when normal use has exhausted the life of a part including, but not limited to, chucks, brushes, cords, saw shoes, blade clamps, o-rings, seals, bumpers, driver blades, pistons, strikers, lifters, and bumper cover washers.

*This warranty does not cover Air Nailers & Staplers; Airless Paint Sprayer; Cordless Battery Packs; Gasoline Driven Portable Power Generators; Hand Tools; Hoist - Electric, Lever & Hand Chain; M12™ Heated Gear; Reconditioned Product; and Test & Measurement Products. There are separate and distinct warranties available for these products.

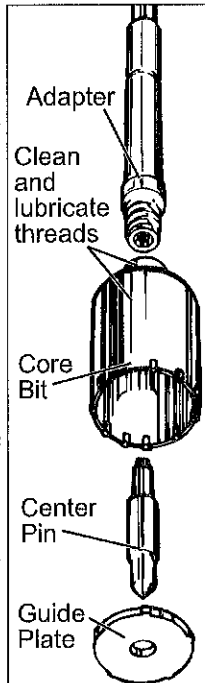

**The warranty period for Job Site Radios, M12™ Power Port, M18™ Power Source, Jobsite Fan and Trade Titan™ Industrial Work Carts is one (1) year from the date of purchase. The warranty period for the Drain Cleaning Cables is two (2) years from the date of purchase. The warranty period for the M18™ Compact Heat Gun and the 8 Gallon Dust Extractor is three (3) years from the date of purchase. The warranty period for the LED in the LED Work Light and the LED Upgrade Bulb for the Work Light is the lifetime of the product subject to the limitations above. If during normal use the LED or LED Bulb fails, the part will be replaced free of charge.

Warranty Registration is not necessary to obtain the applicable warranty on a MILWAUKEE power tool product. The manufacturing date of the product will be used to determine the warranty period if no proof of purchase is provided at the time warranty service is requested. ACCEPTANCE OF THE EXCLUSIVE REPAIR AND REPLACEMENT REMEDIES DESCRIBED HEREIN IS A CONDITION OF THE CONTRACT FOR THE PURCHASE OF EVERY MILWAUKEE PRODUCT. IF YOU DO NOT AGREE TO THIS CONDITION, YOU SHOULD NOT PURCHASE THE PRODUCT. IN NO EVENT SHALL MILWAUKEE BE LIABLE FOR ANY INCIDENTAL, SPECIAL, CONSEQUENTIAL OR PUNITIVE DAMAGES, OR FOR ANY COSTS, ATTORNEY FEES, EXPENSES, LOSSES OR DELAYS ALLEGED TO BE AS A CONSEQUENCE OF ANY DAMAGE TO, FAILURE OF, OR DEFECT IN ANY PRODUCT INCLUDING, BUT NOT LIMITED TO, ANY CLAIMS FOR LOSS OF PROFITS. SOME STATES DO NOT ALLOW THE EXCLUSION OR LIMITATION OF INCIDENTAL OR CONSEQUENTIAL DAMAGES, SO THE ABOVE LIMITATION OR EXCLUSION MAY NOT APPLY TO YOU. THIS WARRANTY IS EXCLUSIVE AND IN LIEU OF ALL OTHER EXPRESS WARRANTIES, WRITTEN OR ORAL. TO THE EXTENT PERMITTED BY LAW, MILWAUKEE DISCLAIMS ANY IMPLIED WARRANTIES, INCLUDING WITHOUT LIMITATION ANY IMPLIED WARRANTY OF MERCHANTABILITY OR FITNESS FOR A PARTICULAR USE OR PURPOSE; TO THE EXTENT SUCH DISCLAIMER IS NOT PERMITTED BY LAW, SUCH IMPLIED WARRANTIES ARE LIMITED TO THE DURATION OF THE APPLICABLE EXPRESS WARRANTY AS DESCRIBED ABOVE. SOME STATES DO NOT ALLOW LIMITATIONS ON HOW LONG AN IMPLIED WARRANTY LASTS, SO THE ABOVE LIMITATION MAY NOT APPLY TO YOU, THIS WARRANTY GIVES YOU SPECIFIC LEGAL RIGHTS, AND YOU MAY ALSO HAVE OTHER RIGHTS WHICH VARY FROM STATE TO STATE.

This warranty applies to product sold in the U.S.A. and Canada only. Please consult the 'Service Center Search' in the Parts & Service section of MILWAUKEE's website www.milwaukeeeetool.com or call 1.800.SAWDUST (1.800.729.3878) to locate your nearest service facility for warranty and non-warranty service on a Milwaukee electric power tool.

LIMITED WARRANTY - MEXICO, CENTRAL AMERICA & CARIBBEAN

TECHTRONIC INDUSTRIES' warranty is for 5 years since the original purchase date.

This warranty card covers any defect in material and workmanship on this Product.

To make this warranty valid, present this warranty card, sealed/stamped by the distributor or store where you purchased the product, to the Authorized Service Center (ASC). Or, if this card has not been sealed/stamped, present the original proof of purchase to the ASC. Call toll-free 1 01 (800) 030-7777 to find the nearest ASC, for service, parts, accessories or components.

Procedure to make this warranty valid

Take the product to the ASC, along with the warranty card sealed/stamped by the distributor or store where you purchased the product, and any faulty piece or component will be replaced without cost for you. We will cover all freight costs relative with this warranty process.

Exceptions

This warranty is not valid in the following situations

- When the product is used in a different manner from the end-user guide or instruction manual.
- When the conditions of use are not normal.
- When the product was modified or repaired by people not authorized by TECHTRONIC INDUSTRIES.

Note: If cord set is damaged, it should be replaced by an Authorized Service Center to avoid electric risks.

SERVICE AND ATTENTION CENTER
Call to 01 (800) 030-7777

IMPORTED AND COMMERCIALIZED BY
TECHTRONIC INDUSTRIES MEXICO, SA DE CV
Av President Masarik #29 piso 7, Col. Polanco V Sección
CP 11560, Deleg. Miguel Hidalgo, CDMX

RÈGLES DE SÉCURITÉ GÉNÉRALES RELATIVES AUX OUTILS ÉLECTRIQUES

AVERTISSEMENT Lire toutes les consignes de sécurité, consignes, illustrations et spécifications fournies avec cet outil électrique. Ne pas suivre l'ensemble des règles et instructions peut entraîner une électrocution, un incendie ou des blessures graves. **Conserver les règles et les instructions à des fins de référence ultérieure.** Le terme «outil électrique» figurant dans les avertissements ci-dessous renvoie à l'outil électrique à alimentation par le réseau (à cordon) ou par batterie (sans fil).

SÉCURITÉ DU LIEU DE TRAVAIL

- **Veillez à ce que l'aire de travail soit propre et bien éclairée.** Le désordre et le manque de lumière favorisent les accidents.
- **Ne pas utiliser d'outils électriques dans des atmosphères explosives, par exemple en présence de liquides, gaz ou poussières inflammables.** Les outils électriques produisent des étincelles risquant d'enflammer les poussières ou vapeurs.
- **S'assurer que les enfants et les curieux se trouvent à une bonne distance au moment d'utiliser un outil électrique.** Les distractions peuvent causer une perte de contrôle.

SÉCURITÉ ÉLECTRIQUE

- **Les fiches des outils électriques doivent correspondre à la prise secteur utilisée. Ne jamais modifier la fiche, de quelque façon que ce soit. Ne jamais utiliser d'adaptateurs de fiche avec des outils mis à la terre.** Les fiches et prises non modifiées réduisent le risque de choc électrique.
- **Éviter tout contact avec des surfaces mises à la terre comme des tuyaux, des radiateurs, des cuisinières et des réfrigérateurs.** Le risque de choc électrique est accru lorsque le corps est mis à la terre.
- **Ne pas exposer les outils électriques à l'eau ou l'humidité.** La pénétration d'eau dans ces outils accroît le risque de choc électrique.
- **Ne pas maltraiter le cordon d'alimentation. Ne jamais utiliser le cordon d'alimentation pour transporter l'outil électrique et ne jamais débrancher ce dernier en tirant sur le cordon. Garder le cordon à l'écart de la chaleur, de l'huile, des objets tranchants et des pièces en mouvement.** Un cordon endommagé ou emmêlé accroît le risque de choc électrique.
- **Pour les travaux à l'extérieur, utiliser un cordon spécialement conçu à cet effet.** Utiliser un cordon conçu pour l'usage extérieur réduit les risques de choc électrique.
- **Si l'utilisation d'un outil électrique est inévitable dans un endroit humide, utiliser une source d'alimentation munie d'un disjoncteur de fuite de terre.** L'utilisation d'un disjoncteur de fuite de terre réduit le risque de choc électrique.

SÉCURITÉ INDIVIDUELLE

- **Rester attentif, prêter attention au travail et faire preuve de bon sens lors de l'utilisation de tout outil électrique. Ne pas utiliser cet appareil en cas de fatigue ou sous l'influence de l'alcool, de drogues ou de médicaments.** Un moment d'inattention pendant l'utilisation d'un outil électrique peut entraîner des blessures graves.
- **Porter l'équipement de protection individuel requis. Toujours porter une protection oculaire.** Selon les conditions, porter aussi un masque antipoussières, des bottes de sécurité antidérapantes, un casque protecteur ou une protection auditive afin de réduire les blessures.

Model: _____

Date of Purchase: _____

Distributor or Store Stamp: