

Worklight

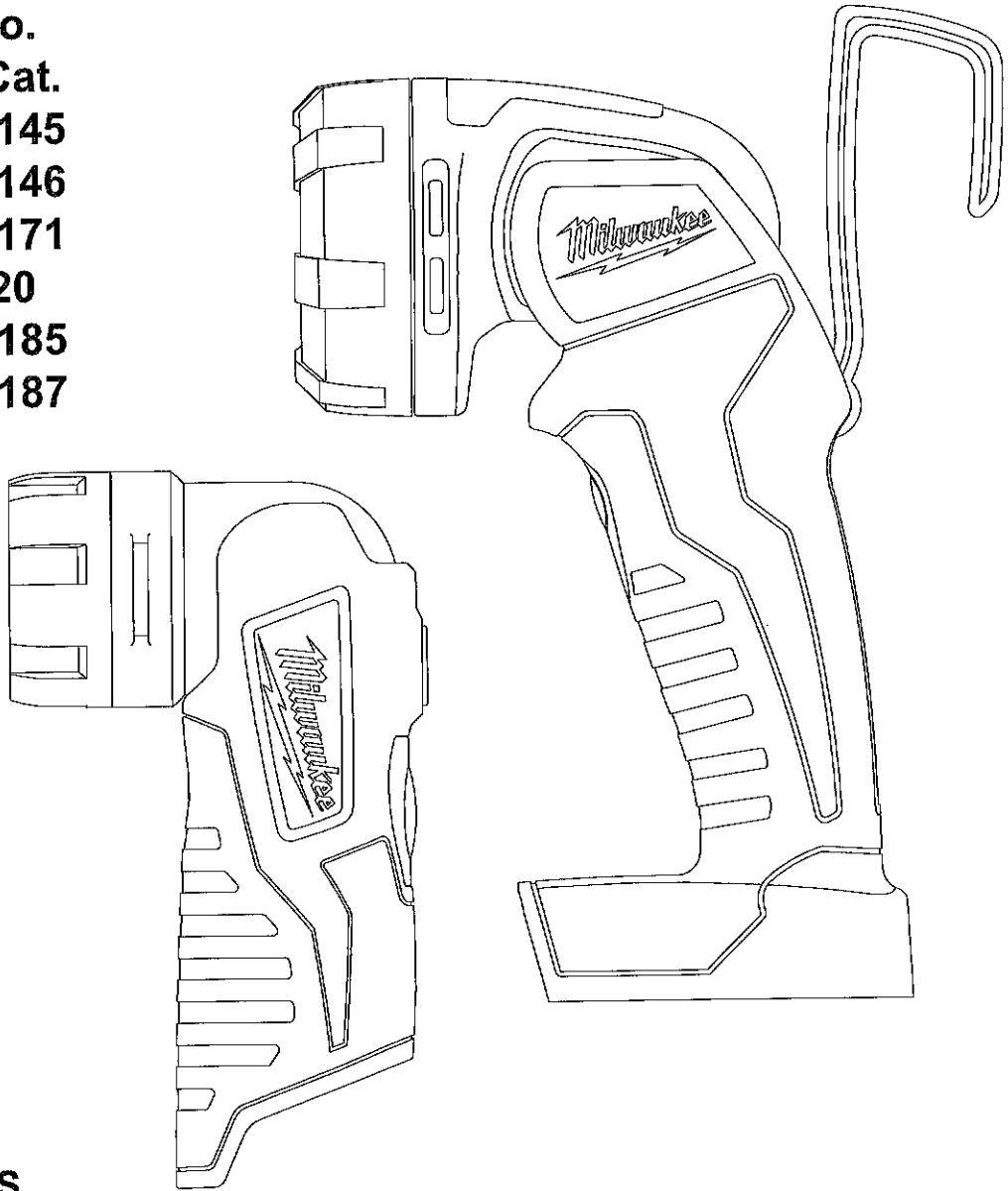

**OPERATOR'S MANUAL  
MANUEL de L'UTILISATEUR  
MANUAL del OPERADOR**

**Cat. No.  
No de Cat.  
49-24-0145  
49-24-0146  
49-24-0171  
2735-20  
49-24-0185  
49-24-0187**



**WORKLIGHTS  
LAMPE DE TRAVAIL  
LAMPARA DE TRABAJO**

**TO REDUCE THE RISK OF INJURY, USER MUST READ AND UNDERSTAND OPERATOR'S MANUAL.**

**AFIN DE RÉDUIRE LE RISQUE DE BLESSURES, L'UTILISATEUR DOIT LIRE ET BIEN COMPRENDRE LE MANUEL DE L'UTILISATEUR.**

**PARA REDUCIR EL RIESGO DE LESIONES, EL USUARIO DEBE LEER Y ENTENDER EL MANUAL DEL OPERADOR.**

# IMPORTANT SAFETY INSTRUCTIONS

**⚠ WARNING** READ AND UNDERSTAND ALL INSTRUCTIONS. When using electric appliances, basic precautions should always be followed, including the following:

Before using the work light, read this operator's manual, your battery pack and charger operator's manual, and all labels on the battery pack, charger and work light.

- **Read and understand all the instructions before using the appliance.**
- **To reduce the risk of injury, close supervision is necessary** when an appliance is used near children.
- **Warning - The lens gets very hot during use.** To reduce the risk of burns, do not touch hot lens.
- **Never insert bulbs other than MILWAUKEE bulbs in the bulb socket.** Bulbs other than MILWAUKEE bulbs may cause short circuit of battery and personal injury.
- **Store idle work light out of reach of children.** Warm work lights can become hazardous in the hands of children.
- **Do not use outdoors.**
- **For a rechargeable appliance** - Use only the charger supplied by the manufacturer to recharge.
- **For an appliance with a replaceable lamp** - always unplug or remove battery pack before replacing the lamp. See "Specifications" for replacement bulbs.
- **Know your work light.** Read this manual carefully to learn your work light's applications and limitations as well as potential hazards associated with this type of tool.
- **Batteries must be recharged only with the charger specified by the manufacturer.** A charger that may be suitable for one type of battery may create a risk of fire when used with another battery.
- **Use work light only with specifically designated battery pack.** Use of any other batteries may create a risk of fire.
- **When battery pack is not in use, keep it away from metal objects like: paper clips, coins, keys, nails, screws, or other small metal objects that can make a connection from one terminal to another.** Shorting the battery terminals together may cause sparks, burns, or a fire.
- **Maintain labels and nameplates.** These carry important information. If unreadable or missing, contact a MILWAUKEE service facility for a free replacement.



**SAVE THESE INSTRUCTIONS**

## SPECIFICATIONS

Cat. No.	Volts DC	Replacement Bulbs	For use with Battery Packs:
49-24-0185	28	49-81-0040	48-11-2830 28 V Li-Ion or equivalent
49-24-0187	28	n/a *	48-11-2830 28 V Li-Ion or equivalent
49-24-0171	18	49-81-0030	Use only MILWAUKEE M18™ Li-Ion battery packs.
2735-20	18	n/a *	Use only MILWAUKEE M18™ Li-Ion battery packs.
49-24-0145	12	49-81-0020	Use only MILWAUKEE M12™ Li-Ion battery packs.
49-24-0146	12	n/a *	Use only MILWAUKEE M12™ Li-Ion battery packs.

\*LED worklights do not require replacement parts.

## SYMBOLOLOGY

V	Volts
---	Direct Current
	Underwriters Laboratories, Inc. United States and Canada
	Underwriters Laboratories, Inc.

## FUNCTIONAL DESCRIPTION

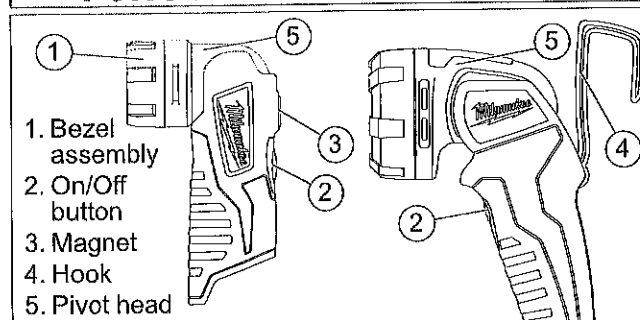

## ASSEMBLY

**⚠ WARNING** Recharge only with the charger specified for the battery. For specific charging instructions, read the operator's manual supplied with your charger and battery.

### Inserting/Removing Battery Pack

Insert the battery pack by sliding battery pack into the body of the tool. Insert the battery pack until the battery latches lock.

To remove the battery pack, press in both battery latches and slide the battery pack off of the tool.

**⚠ WARNING** To reduce the risk of injury, do not look directly into the light when the work light is on.

## Adjusting the Pivot Head

Cat. No. 2735-20, 49-24-0145 and 49-24-0146 -

The pivot head can pivot to a range of 90°; with detents every 15° (every 10° for the 2735-20). Pivot head to desired position. Allow the detent to snap into place. Do not forcibly pivot the head.

Cat. No. 49-24-0171, 49-24-0187, and 49-24-0185 - The pivot head can pivot to a range of 135°; with detents every 10°. Pivot head to desired position. Allow the detent to snap into place. Do not forcibly pivot the head.

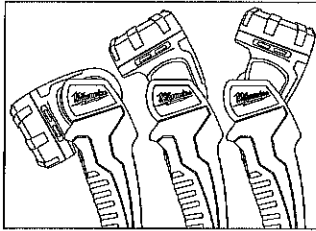

**▲ WARNING** To reduce the risk of injury, DO NOT operate work light without bezel assembly in place. Bulb does get hot. Always remove battery pack before changing or removing bulbs. Always allow the work light to cool for at least 10 minutes before replacing the bulb.

## Replacing the Bulb (Cat. No. 49-24-0145, 49-24-0171, and 49-24-0185)

NOTE: Cat. No. 49-24-0146, 2735-20, and 49-24-0187 use an LED bulb that cannot be replaced. Bezel can not be removed. Attempting to remove the bezel will damage tool.

1. Remove battery pack before changing bulb.
2. Unscrew the bezel assembly on pivot head by turning counterclockwise.
3. Remove the bezel assembly.
4. For Cat. No. 49-24-0185 and 49-24-0171, pull the aluminum heat sink forward.
5. Gently rotate bulb counter clockwise and pull out.

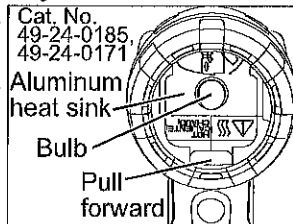

To install new bulb, follow above directions in reverse.

**▲ WARNING** To reduce the risk of injury and damage, never insert bulbs other than the recommended **MILWAUKEE** replacement bulb in the bulb socket. Other bulbs will over heat!

NOTE: Use a soft cloth when installing bulbs. Direct contact with oils or other contamination can shorten the life of bulbs.

On Cat. No. 49-24-0171 and 49-24-0185, a spare bulb can be stored behind the aluminum heat sink. See "Specifications" chart for proper replacement bulbs. See your nearest **MILWAUKEE** Retailer or Service Center to obtain replacement bulbs.

## OPERATION

To turn **on** the work light, press the ON/OFF button. To turn **off** the work light, press the ON/OFF button again.

**Hook**  
Cat.No. 2735-20, 49-24-0185, 49-24-0187 and 49-24-0171)

To use the hanging hook, press in the hook joint. Pull the hook out.

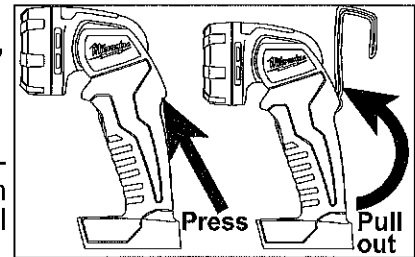

## MAINTENANCE

**▲ WARNING** To reduce the risk of injury, always unplug the charger and remove the battery pack from the charger or tool before performing any maintenance. Never disassemble the tool, battery pack or charger. Contact a **MILWAUKEE** service facility for ALL repairs.

### Maintain Work Light

Keep your work light, battery pack and charger in good repair by adopting a regular maintenance program. If the work light does not work properly, return the work light to a **MILWAUKEE** service facility for repairs.

**▲ WARNING** To reduce the risk of personal injury and damage, never immerse your tool, battery pack or charger in liquid or allow a liquid to flow inside them.

### Cleaning

Keep tool handles clean, dry and free of oil or grease. Use only mild soap and a damp cloth to clean the tool, battery pack and charger since certain cleaning agents and solvents are harmful to plastics and other insulated parts. Some of these include gasoline, turpentine, lacquer thinner, paint thinner, chlorinated cleaning solvents, ammonia and household detergents containing ammonia. Never use flammable or combustible solvents around tools.

## ACCESSORIES

**▲ WARNING** Always remove battery pack before changing or removing accessories. Only use accessories specifically recommended for this tool. Others may be hazardous.

For a complete listing of accessories refer to your **MILWAUKEE** Electric Tool catalog or go online to [www.milwaukeetool.com](http://www.milwaukeetool.com). To obtain a catalog, contact your local distributor or a service center.

## LIMITED WARRANTY - USA AND CANADA

Every MILWAUKEE power tool (including cordless product – tool, battery pack(s) - see separate & distinct CORDLESS BATTERY PACK LIMITED WARRANTY statements & battery charger and Work Lights\*) is warranted to the original purchaser only to be free from defects in material and workmanship. Subject to certain exceptions, MILWAUKEE will repair or replace any part on an electric power tool which, after examination, is determined by MILWAUKEE to be defective in material or workmanship for a period of five (5) years\* after the date of purchase unless otherwise noted. Return of the power tool to a MILWAUKEE factory Service Center location or MILWAUKEE Authorized Service Station, freight prepaid and insured, is required. A copy of the proof of purchase should be included with the return product. This warranty does not apply to damage that MILWAUKEE determines to be from repairs made or attempted by anyone other than MILWAUKEE authorized personnel, misuse, alterations, abuse, normal wear and tear, lack of maintenance, or accidents.

\*The warranty period for, Job Site Radios, M12™ Power Port, M18™ Power Source, and Trade Titan™ Industrial Work Carts is one (1) year from the date of purchase. The warranty period for a LED Work Light and LED Upgrade Bulb is a limited LIFETIME warranty to the original purchaser only, if during normal use the LED bulb fails the Work Light or Upgrade Bulb will be replaced free of charge.

\*This warranty does not cover Air Nailers & Stapler, Airless Paint Sprayer, Cordless Battery Packs, Gasoline Driven Portable Power Generators, Hand Tools, Hoist – Electric, Lever & Hand Chain, M12™ Heated Jackets, Reconditioned product and Test & Measurement products. There are separate and distinct warranties available for these products.

Warranty Registration is not necessary to obtain the applicable warranty on a MILWAUKEE power tool product. The manufacturing date of the product will be used to determine the warranty period if no proof of purchase is provided at the time warranty service is requested.

ACCEPTANCE OF THE EXCLUSIVE REPAIR AND REPLACEMENT REMEDIES DESCRIBED HEREIN IS A CONDITION OF THE CONTRACT FOR THE PURCHASE OF EVERY MILWAUKEE PRODUCT. IF YOU DO NOT AGREE TO THIS CONDITION, YOU SHOULD NOT PURCHASE THE PRODUCT. IN NO EVENT SHALL MILWAUKEE BE LIABLE FOR ANY INCIDENTAL, SPECIAL, CONSEQUENTIAL OR PUNITIVE DAMAGES, OR FOR ANY COSTS, ATTORNEY FEES, EXPENSES, LOSSES OR DELAYS ALLEGED TO BE AS A CONSEQUENCE OF ANY DAMAGE TO, FAILURE OF, OR DEFECT IN ANY PRODUCT INCLUDING, BUT NOT LIMITED TO, ANY CLAIMS FOR LOSS OF PROFITS. SOME STATES DO NOT ALLOW THE EXCLUSION OR LIMITATION OF INCIDENTAL OR CONSEQUENTIAL DAMAGES, SO THE ABOVE LIMITATION OR EXCLUSION MAY NOT APPLY TO YOU. THIS WARRANTY IS EXCLUSIVE AND IN LIEU OF ALL OTHER EXPRESS WARRANTIES, WRITTEN OR ORAL. TO THE EXTENT PERMITTED BY LAW, MILWAUKEE DISCLAIMS ANY IMPLIED WARRANTIES, INCLUDING WITHOUT LIMITATION ANY IMPLIED WARRANTY OF MERCHANTABILITY OR FITNESS FOR A PARTICULAR USE OR PURPOSE; TO THE EXTENT SUCH DISCLAIMER IS NOT PERMITTED BY LAW, SUCH IMPLIED WARRANTIES ARE LIMITED TO THE DURATION OF THE APPLICABLE EXPRESS WARRANTY AS DESCRIBED ABOVE. SOME STATES DO NOT ALLOW LIMITATIONS ON HOW LONG AN IMPLIED WARRANTY LASTS, SO THE ABOVE LIMITATION MAY NOT APPLY TO YOU, THIS WARRANTY GIVES YOU SPECIFIC LEGAL RIGHTS, AND YOU MAY ALSO HAVE OTHER RIGHTS WHICH VARY FROM STATE TO STATE. This warranty applies to product sold in the U.S.A. and Canada only.

Please consult the 'Service Center Search' in the Parts & Service section of MILWAUKEE's website [www.milwaukee.com](http://www.milwaukee.com) or call **1.800.SAWDUST (1.800.729.3878)** to locate your nearest service facility for warranty and non-warranty service on a Milwaukee electric power tool.

## LIMITED WARRANTY - MEXICO, CENTRAL AMERICA AND CARIBBEAN

TECHTRONIC INDUSTRIES' warranty is for 5 year since the original purchase date.

This warranty card covers any defect in material and workmanship on this Power Tool.

To make this warranty valid, present this warranty card, sealed/stamped by the distributor or store where you purchased the product, to the Authorized Service Center (ASC). Or, if this card has not been sealed/stamped, present the original proof of purchase to the ASC.

Call toll-free 1 800 832 1949 to find the nearest ASC, for service, parts, accessories or components.

### **Procedure to make this warranty valid**

Take the product to the ASC, along with the warranty card sealed/stamped by the distributor or store where you purchased the product, and there any faulty piece or component will be replaced without cost for you. We will cover all freight costs relative with this warranty process.

### **Exceptions**

This warranty is not valid in the following situations:

- When the product is used in a different manners from the end-user guide or instruction manual.
- When the conditions of use are not normal.
- When the product was modified or repaired by people not authorized by TECHTRONIC INDUSTRIES.

Note: If cord set is damaged, it should be replaced by an Authorized Service Center to avoid electric risks.

Model: \_\_\_\_\_

Date of Purchase: \_\_\_\_\_

Distributor or Store Stamp:

SERVICE AND ATTENTION CENTER  
Av Presidente Mazarik 29 Piso 7, 11570 Chapultepec Morales  
Miguel Hidalgo, Distrito Federal, Mexico  
Ph. 52 55 4160-3547

IMPORTED AND COMMERCIALIZED BY:  
TECHTRONIC INDUSTRIES MEXICO, S.A. DE C.V.  
Av Presidente Mazarik 29 Piso 7, 11570 Chapultepec Morales  
Miguel Hidalgo, Distrito Federal, Mexico