

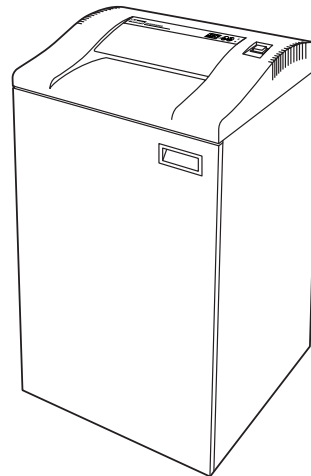

Powershred® Console Shredders



220/220CC
280/280CC
320/320CC
380/380CC

Operating Instructions

A

Mode d'emploi

B

Instrucciones de funcionamiento

C

Bedienungsanleitung

D

Bedieningsinstructies

E

Istruzioni sul funzionamento

F

A

B

C

D

E

F

English

Important Safety Instructions	3
Parts Identification	4
Technical Specifications	5-6
Installation, Operation	7
Checklist for Inoperative Machine	8
Maintenance, Supplies, Warranty	9
Declaration of Conformity	10
Contact For Service	51

Français

Consignes de sécurité importantes	11
Identification des pièces	12
Caractéristiques techniques	13-14
Installation, Mode d'emploi	15
Liste de contrôle lorsque l'équipement ne fonctionne pas	16
Entretien, Fournitures, Garantie	17
Déclaration de Conformité	18
Contact For Service	51

Español

Medidas de seguridad importantes	19
Identificación de las piezas	20
Especificaciones	21-22
Instalación, Modo de empleo	23
Procedimiento en caso de funcionamiento incorrecto	24
Mantenimiento, Artículos consumibles, Garantía	25
Declaración de conformidad	26
Contact For Service	51

Deutsch

Wichtige Sicherheitshinweise	27
Identifizierung der Teile	28
Technische Daten	29-30
Montage und Aufstellung, Betrieb	31
Checkliste für betriebsunfähige Geräte	32
Wartung, Materialien, Garantie	33
Konformitätserklärung	34
Contact for Service (Service Adressen)	51

Nederlands

Belangrijke veiligheidsinstructies	35
Onderdelen	36
Specificaties	37-38
Installatie en bediening van de machine	39
Checklist voor een niet-functionerende papiervernietiger	40
Onderhoud, Toebehoren, Garantie	41
Verklaring van Conformiteit	42
Contact For Service	51

Italiano

Importanti istruzioni sulla sicurezza	43
Identificazione dei pezzi	44
Specifiche tecniche	45-46
Installazione, Funzionamento	47
Lista di controllo per apparecchi non funzionanti	48
Manutenzione, Accessori, Garanzia	49
Dichiarazione sulla conformità	50
Contact For Service	51

Important Safety Instructions

1. Read all instructions before use.
2. Save these instructions for later use.
3. Follow all warnings and instructions marked on the product.
4. Unplug this product from the wall outlet before cleaning. Clean with a damp cloth using a mild soap and water solution. (Do not use abrasives or petroleum based cleaners.)
5. Place this product as close as possible to power source for quick and easy unplugging. Do not block the power supply receptacle; it must be possible to conveniently unplug the power cord.
6. Do not use this product near water.
7. This product should never be placed near or over a radiator or heat source.
8. Operate from the type of power source indicated on the marking label. If you are not sure of the type of power available, consult your dealer or local electricity board.
9. Do not allow anything to rest on the power cord. Do not place this product where people may walk on the cord.
10. If an extension cord is used with this product, make sure that the total of the ampere ratings on the products plugged into the extension cord do not exceed the extension cord ampere rating. Also, make sure that the total of all products plugged into the wall outlet does not exceed 15 amps.
11. Do not attempt to service this product yourself, as opening or removing covers may expose you to dangerous live parts or other risks.
12. Unplug this product and refer servicing to qualified personnel under the following conditions:
 - A) When the power cord or plug is damaged or frayed.
 - B) If liquid has been spilled on the product.
 - C) If the product has been exposed to rain.
 - D) If the product does not operate normally when the operating instructions are followed.
 - E) If the product has been dropped or the casing has been damaged.
13. Keep out of the reach of children.
14. This shredder should be operated only with an operator in attendance.

Caution

1. This shredder utilizes a safety interlock switch which lights the red indicator light and stops power to the motor when the door is opened. Do not attempt to override this safety feature.
2. The electronic circuitry in this shredder performs several functions:
 - Senses the presence of paper in the shredder inlet and automatically starts shredding and then stops the shredder approximately 3 seconds after the paper has passed through.
 - Controls the safety functions of the shredder.
 - Operates the indicator lights.
 - (In 320 and 380 series only) Monitors the amount of electrical current being used and stops the motor if too much paper has been put into the shredder or a jam has occurred.
3. The automatic start function of this shredder uses an infrared sensor in the inlet to detect the presence of paper. If a strong light or sunlight is allowed to shine directly into the inlet, the sensor may give a false indication and start the shredder. If this occurs, it does not present a safety hazard. The cover over the inlet will ordinarily prevent this false indication from occurring. If the shredder is in a position where sunlight or a strong lamp shines on the front of the shredder from such a low position that the light reaches down into the inlet:
 - Move the shredder or the light to a different position, OR
 - Turn the rocker switch to the off position when not in use.

CAUTION: Do not insert aerosol cleaners or lubricants into or around the machine. Some agents may combust, causing serious injury.



Parts Identification

- | | |
|---------------------|--|
| 1) Indicator Lights | 5) Cabinet Access Door |
| 2) Rocker Switch | 6) Paper Feed Opening |
| 3) Cover | 7) Power Supply Receptacle |
| 4) Cabinet | 8) Circuit breaker (models 320-380 only) |

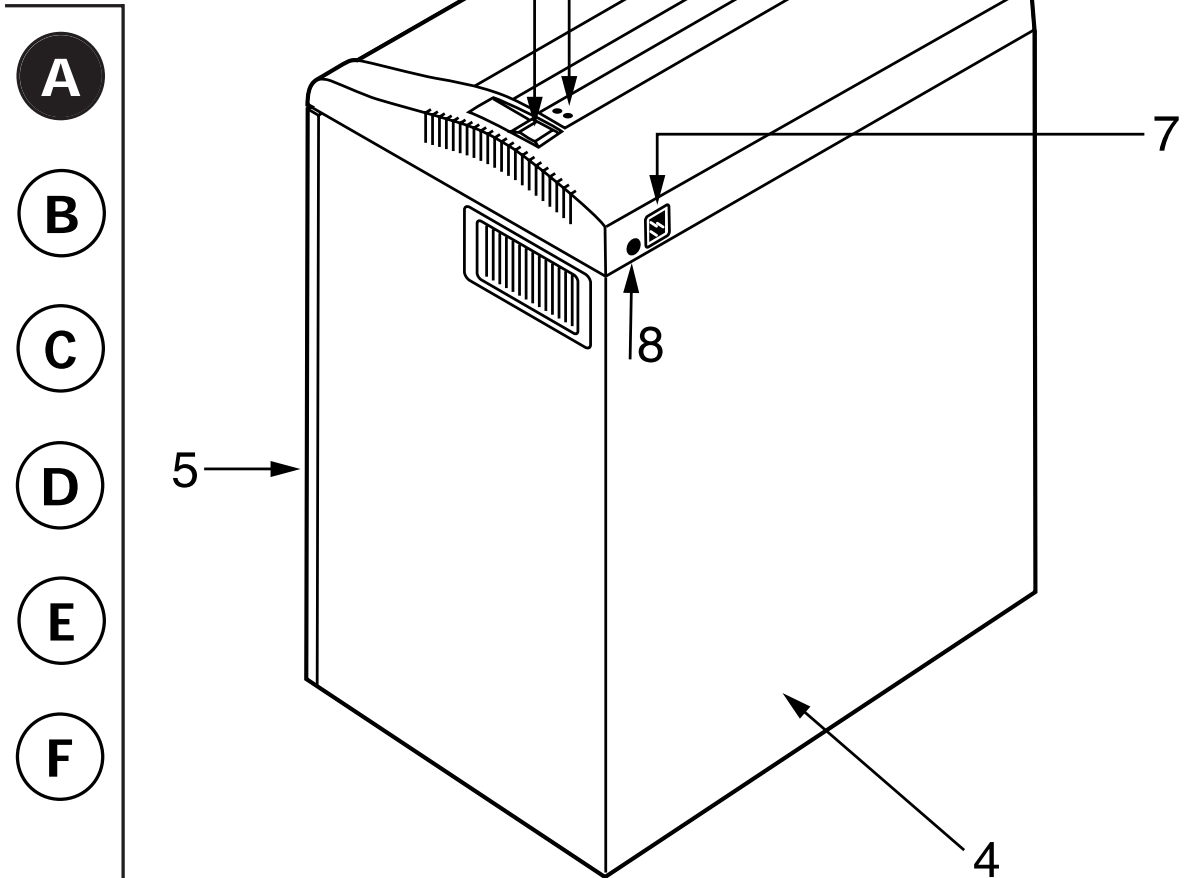

Technical Specifications

Model	220		220CC	280		280CC
Cutting Style	Strip		Cross Cut	Strip		Cross Cut
Shred Size						
Inches	1/4	5/32	5/32 x 1-1/4	1/4	5/32	5/32 x 1-1/4
Millimeters	5.99	3.9	3.9 x 32	5.99	3.9	3.9 x 32
Sheet Capacity						
8-1/2" x 11" 20 lb.	14-16	12-14	8-10	14-16	12-14	8-10
A4/70gr	16-18	14-16	9-11	16-18	14-16	9-11
Speed						
115V, 60Hz	22 FPM		22 FPM	22 FPM		22 FPM
Entry Width						
Inches	10		10	15		15
Millimeters	(254)		(254)	(381)		(381)
Motor Power						
120V	1/4 hp		1/4 hp	1/4 hp		1/4 hp
220-240V	(0.15 kW)		(0.15 kW)	(0.15 kW)		(0.15 kW)
Input voltage (Depending on country)	100V 50/60Hz		100V 50/60Hz	100V 50/60Hz		100V 50/60Hz
	120V 60Hz		120V 60Hz	120V 60Hz		120V 60Hz
	220-240V 50Hz		220-240V 50Hz	220-240V 50Hz		220-240V 50Hz
Dimensions						
Inches	32-3/8 H x 17-3/4 W x 16 D		32-3/8 H x 17-3/4 W x 16 D	32-3/8 H x 23 W x 16 D		32-3/8 H x 23 W x 16 D
Millimeters	822 H x 451 W x 406 D		822 H x 451 W x 406 D	822 H x 584 W x 406 D		822 H x 584 W x 406 D
Weight						
Pounds	73		83	90		100
Kilograms	33		37.6	40.9		45.5
Waste Container Vol.						
Gallons	18.24		18.24	24.75		24.75
Liters	69.0		69.0	93.7		93.7
Reorder bag number	36054		36054	36056		36056

A

B

C

D

E

F

Technical Specifications

Model	320		320CC	380		380CC
Cutting Style	Strip		Cross Cut	Strip		Cross Cut
Shred Size						
Inches	1/4	5/32	5/32 x 1-1/4	1/4	5/32	5/32 x 1-1/4
Millimeters	5.99	3.9	3.9 x 32	5.99	3.9	3.9 x 32
Sheet Capacity						
8-1/2" x 11", 20 lb.	18-20	16-18	10-12	18-20	16-18	10-12
A4/70gr	20-22	18-20	12-14	20-22	18-20	12-14
Speed						
115V, 60Hz	22 FPM		22 FPM	22 FPM		22 FPM
Entry Width						
Inches	10		10	15		15
Millimeters	(254)		(254)	(381)		(381)
Motor Power						
120V	2/5 hp		2/5 hp	2/5 hp		2/5 hp
220-240V	(0.28 kW)		(0.28 kW)	(0.28 kW)		(0.28 kW)
Input voltage (Depending on country)	100V 50/60Hz		100V 50/60Hz	100V 50/60Hz		100V 50/60Hz
	120V 60Hz		120V 60Hz	120V 60Hz		120V 60Hz
	220-240V 50Hz		220-240V 50Hz	220-240V 50Hz		220-240V 50Hz
Dimensions						
Inches	32-3/8 H x 17-3/4 W x 16 D		32-3/8 H x 17-3/4 W x 16 D	32-3/8 H x 23 W x 16 D		32-3/8 H x 23 W x 16 D
Millimeters	822 H x 451 W x 406 D		822 H x 451 W x 406 D	822 H x 584 W x 406 D		822 H x 584 W x 406 D
Weight						
Pounds	78		88	92		102
Kilograms	35.3		39.8	41.8		46.3
Waste Container Vol.						
Gallons	18.24		18.24	24.75		24.75
Liters	69.0		69.0	93.7		93.7
Reorder bag number	36054		36054	36056		36056

A

B

C

D

E

F

Installation

- Plug one end of the enclosed power cord (inside the waste box) into the power supply receptacle in the back of the shredder.
- Screw casters into the nuts provided on the underside of the shredder.
- Operate this product only from the type of power source indicated on the marking label.
- Install the paper shredder so that the plug is easily accessible.
- Operate shredder only in the upright position.
- Set up paper shredder so that the ventilation slots are unobstructed. To ensure sufficient ventilation of the shredder, maintain a minimum distance of 4" (10 cm) from walls or furniture on each side of the shredder.

Caution



Never insert hand, fingers or any foreign objects into the feed opening.

Serious injury may result.



Keep all loose articles of clothing, ties, jewelry, long hair or other loose objects away from feed opening.

Injury may result.

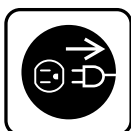

Always turn off and unplug the machine before moving, servicing, cleaning or any other conduct other than normal operation.

Serious injury may result.

Operation



Read operating instructions before putting shredder into operation.

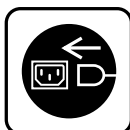

Insert power cord into power supply receptacle on the back of the shredder.

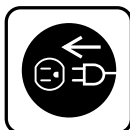

Insert plug into power outlet.

Install waste bag for shredded material

- Open door and completely remove wastebasket from cabinet.
- Fold new bag around frame. Allow bag to overhang waste box by approximately 7" (20 cm).
- Slide box with bag back into cabinet.
- Close cabinet door.

Switching equipment On



- Press rocker switch to (I)
- Switch locks in "on" position
- Equipment is ready for operation (stand by)
- Green LED lights

- Feed paper
- The shredding process is started by photo-cells in the paper feed opening. Insert paper and shredding begins automatically.
- When the shredding is complete, the cutting system automatically stops after approximately 3 seconds.

Switching equipment Off

- Press rocker switch to (O)



A

B

C

D

E

F

Checklist for Inoperative Machines

All Machines

If no indicator lights are lit:

- Make sure the plug is securely inserted in the receptacle on the back of the machine and into the wall outlet.
- Make sure the shredder is on (switch in "I" position).

If both the red and green lights are on:

Waste Box Full:

- Press rocker switch to "O" to stop the cutting system.
- Remove wastebbox from inside cabinet and empty.
- Return wastebbox, close door and resume operation.

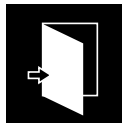

Door Ajar:

- Make sure door is completely closed.
- If the door is opened while the motor is running, after closing the door, set the rocker switch to the "O" position and then to the "I" position to resume operation.

220, 220CC, 280, 280CC

If only the green light is on:

Paper Jam:

- Press rocker switch to "O" to stop the cutting system.
- Press and hold down rocker switch in "R" to reverse the cutting system and back out jammed material (paper is pushed out)
- If the jam persists, slowly move the power switch back and forth between forward (I) and reverse (R), always stopping for a moment in the off position (O). Do not switch the shredder rapidly between forward and reverse to force material through the shredder. Rapid rocking develops tremendous forces that can damage your shredder.
- Continue shredding in smaller quantities so as not to jam the machine further.

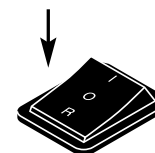
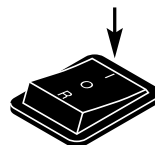
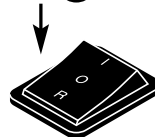

Overheated:

- If the motor is overheated, switch the machine off and allow motor to cool down for approximately 15-20 minutes.

320, 320CC, 380, 380CC

If no lights are on:

- Make sure the circuit breaker is not open. (press to reset).

If only the red light is on:

Paper Jam:

- Press rocker switch to "O" to stop the cutting system.
- Press and hold down rocker switch in "R" to reverse the cutting system and back out jammed material (paper is pushed out). Rocker switch must be held in reverse for a few seconds to cause the red light to turn off.
- If the jam persists, slowly move the power switch back and forth between forward (I) and reverse (R), always stopping for a moment in the off position (O). Do not switch the shredder rapidly between forward and reverse to force material through the shredder. Rapid rocking develops tremendous forces that can damage your shredder.
- Continue shredding in smaller quantities so as not to jam the machine further.

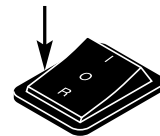
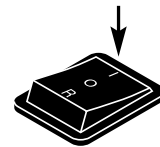
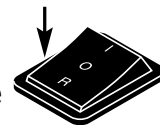

Overheated:

- If the motor is overheated, switch the machine off and allow motor to cool down for approximately 15-20 minutes.

A

B

C

D

E

F

Maintenance

(Cross Cut Units Only)

Shredder Oiling Instructions

When shredding capacity drops, noise increases, or if the cutting cylinders stop with a squeak or a rubbing sound, the cutters should be oiled.

- When lubricating the cutters, utilize POWERSHRED lubricant #35250 or a suitable substitute, i.e., a light weight machine oil or a sewing machine oil. Do not spray an aerosol cleaner or lubricant into the machine. Some agents may combust, causing serious injury. Make certain an extension nozzle is provided so the lubricant can reach well into the throat of the machine.
- Squeeze the lubricant across the full width of the cutters and then turn the machine on and run the cutting system forward for a few seconds (the photo eye must be blocked with a piece of paper in order to run the cutting system forward).
- Then depress the rocker switch in the reverse direction and run the cutting system in reverse for a few seconds.

Repeat the procedure.

Supplies

- Bags for cut material (Packed in dispenser carton, 50 bags to a roll. Contact Fellowes or your local Fellowes dealer for the stock number of the bag that fits your machine.)
- Cutting block oil for cross-cut units: Stock #35250
- Replacement wastebins and handles are available from Fellowes. Please call Fellowes customer service for ordering information.

Warranty

Fellowes Powershred Limited Warranty

1 year on all parts and labor

5 years parts and labor on cutting cylinders

Fellowes warrants this product to be free from defects in material and workmanship for a period

of one year from the date of purchase by the original consumer. At its option, Fellowes will repair or replace without charge for material or labor, any component found to be defective during the warranty period. Additionally, the cutting cylinders are warranted for 5 years from the original purchase date and will be replaced without charge for material or labor if found by Fellowes to be defective.

Warranty Exclusions

The parties agree that the buyer's sole and exclusive remedy against Fellowes shall be for the repair or replacement of defective parts as provided herein. The buyer agrees that no other remedy (including, but not limited to, incidental or consequential damages for lost profits, lost sales, injury to property or any other incidental or consequential loss) shall be available to him. This warranty shall NOT apply and is void under the following circumstances:

1. When this product or any part thereof has been subjected to accident, alteration, abuse, or misuse.
2. When the shredder's recommended sheet capacity (per specifications on page 5-6) has been exceeded (resulting in a paper jam).
3. When the original Model and Serial Number Plate has been altered, effaced or removed.
4. When repair or service covered under this warranty (other than routine maintenance as described in the Owner's Manual) has been performed by personnel without the express written consent of Fellowes.
5. When the product has been used pursuant to any verbal or written rental, lease or loan agreement.

This warranty described herein shall be in lieu of any other warranty, expressed or implied, including, but not limited to, any implied warranty of merchantability or fitness for a particular purpose. Any representations or promises inconsistent with or in addition to this warranty are unauthorized and shall not be binding upon Fellowes.

A

B

C

D

E

F

Declaration of Conformity

Fellowes Manufacturing Company
Doncaster Road, Kirk Sandall
Doncaster, South Yorkshire, DN31H England

declares that the product
Models Powershred 220, 220CC, 280, 280CC, 320, 320CC, 380 and 380CC,
conform with the requirements of the Low Voltage Directive (73/23 EEC) and the Electromagnetic Compatibility
Directive (89/336 EEC) and the following harmonized European Normes (EN Standards) and IEC Standards.

Safety: EN60950 'Information Technology Equipment'

EMC:	Standard	Severity Level	Performance Criteria
	EN 55014:1995	See Details Below	See Details Below
	EN 55014-2:1997		
	EN 61000-4-2:1995 + A1:1998	4kV Contact, 8kV Air	B
	EN 61000-4-4:1995	1kV 5/50ns, 5kHz, AC Mains	B
	ENV 50142:1994	1kV Differential Mode (Line-Line)	B
	EN 61000-4-5:1995	2kV Common Mode (Line-Gnd)	
	ENV 50141:1993	3V, 150kHz to 230MHz	A
	EN 61000-4-6:1996	80% 1kHz Modulation	
	EN 61000-4-11	10ms dropout, 200ms 60% variation, 1 sec 30% variation.	C
	EN 55014-1:1993 +A1:1997 +A2:1998	Household Limits, Table 1&2	N/A
	EN 61000-3-2:1995 +A1:1998 +A2:1998	Class A, Section 7.1 Table 1	N/A
	EN 61000-3-3:1995	Section 5	N/A

Itasca, Illinois, USA
May 15, 1999

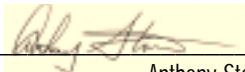
Anthony Storrie

A

B

C

D

E

F

A

B

C

D

E

F

Contact For Service:

United States	1-800-955-0959
Australia	(In Melbourne) (03) 9330-3211 (Outside Melbourne) 1-800-331-177
Canada	1-800-665-4339
United Kingdom	01302-885 331
Japan	+81-3-5496-2401
Benelux	+31-(0)347-377988
Italy	+39-071730041
Germany	+49-5131-49770
France	+33-(0)4-72-08-25-45

Fellowes®

1789 Norwood Avenue • Itasca, Illinois 60143-1095
630-893-1600 • Customer Service 1-800-955-0959
<http://www.fellowes.com>

Australia Tullamarine, Victoria	Benelux Vianen, The Netherlands	Canada Markham, Ontario	Deutschland Hanover, Garbsen	France Montanay, Lyon	Italy Via Dante Alighieri, Camerano (An)	Japan Tokyo	United Kingdom Doncaster, South Yorkshire
--	--	--------------------------------------	---	------------------------------------	---	-----------------------	--

© 1999 Fellowes Printed in U.S.A. Part No. 34288