

EXCAVATION SAFETY

OVERVIEW

Part 1926 of 29 CFR Subpart P - Excavations - OSHA Federal Register, was amended October 31, 1989. Strict compliance with this Standard is required and may call for special measures to ensure compliance.

The standard states that a competent person must first classify the soil by using at least one visual test, and at least one manual test. The competent person shall do an inspection each day prior to entry. Once the test is complete, the standard allows several different options of sloping or benching. The spoil pile must be retained back from the edge of the excavation by at least two feet. All employees working in the excavation shall wear hard hats and when the excavation is close to vehicle traffic all employees shall wear highly visible vests. Before any employees enter the excavation a means of egress shall be used and maintained at least with in twenty-five feet of the employees working. If you have any questions on an excavation or the excavation standard consult with your supervisor.

PURPOSE:

To define a general guideline for work to be performed in open excavations made in the earth's surface. It is **E Light's** program to provide a safe and healthful workplace to the extent of providing methods of protecting employees against cave-ins and describes safe work practices for employees during excavations and trenching operations. All excavations must be in compliance with established OSHA rules and Regulations 29 CFR 1926 Subpart P.

ASSIGNMENT OF RESPONSIBILITY

A. Employer

In administering this Excavation Program, E Light Electric Services Inc. will:

1. Monitor the overall effectiveness of the program.
2. Provide atmospheric testing and equipment selection as needed.
3. Provide personal protective equipment as needed.
4. Provide protective systems as needed.
5. Provide training to affected employees and supervisors.
6. Provide technical assistance as needed.
7. Review and update the program on at least every three years, or as needed.

B. Site Construction Manager/Superintendent

The Site Construction Manager or Superintendent has the overall responsibility to ensure that:

1. The procedures described in this program are followed.
2. Employees entering excavations or trenches are properly trained and equipped to perform their duties safely.
3. All required inspections, tests, and recordkeeping functions have been performed.
4. A designated Competent Person is present at each job site or specific location.

C. Competent Person

E Light Electric Services Inc. shall designate a Competent Person at each job site or specific location. The Competent Person shall conduct daily inspections of the excavation, protective systems, and adjacent areas. The Competent Person is responsible for ensuring:

1. Inspections are conducted:
 - Daily
 - As needed
 - Any time conditions change which could increase the hazards in or near the excavation.
2. Employees do not enter an excavation when it is unsafe to do so.
3. Adequate means of protection are implemented as needed prior to any employee being permitted to enter the excavation.
4. The conditions of the excavation are monitored throughout the activity within or near the excavation.
5. The excavation is evacuated any time a hazardous situation is identified.

D. Employees

All employees, including contract personnel, who work in or around excavations, must comply with the requirements of this program. Employees are responsible for reporting hazardous practices or situations to E Light management, as well as reporting incidents that cause injury to themselves or other employees to the Construction Manager or Superintendent and The Director of Safety and Loss Prevention.

DEFINITIONS APPLICABLE

- **Accepted Engineering Practices:** Requirements, which are compatible with standards of practice, required by a registered professional engineer.
- **Bell Bottom Pier Hole:** Type of shaft or footing excavations, the bottom of which is made larger than the cross section above to form a belled shape.
- **Benching:** Method of protecting employees from cave-ins by excavating the sides of an excavation to form one or a series of horizontal levels or steps, usually with vertical or near-vertical surfaces between levels.
- **Cave-in:** Separation of a mass of soil or rock material from the side of an excavation, or the loss of soil from under a trench shield or support system. The soil its sudden movement into the excavation, either by falling or sliding, in sufficient quantity so that it could entrap, bury or otherwise injure and immobilize a person or persons.
- **Competent Person:** A person who is capable of identifying existing and predictable hazards in the surroundings or working conditions which are unsanitary, hazardous, or dangerous to employees, and who has authority to take prompt corrective measures to eliminate them.
- **Excavation:** Any man-made cut, cavity, trench or depression in the earth's surface, formed by earth removal.
- **Hazardous Atmosphere:** Atmosphere with potential of being explosive, flammable, poisonous, corrosive, oxidizing, irritating, oxygen deficient or otherwise harmful, may cause death or illness or injury.
- **Sloping:** A method of protecting employees from cave-ins by excavating to form sides of an excavation that are inclined away from the excavation so as to prevent cave-ins. The angle of incline required to prevent a cave-in varies with differences in such factor as the soil type, environmental conditions of exposing and application of surcharge loads.
- **Tabulated Data:** Tables and charts approved by a registered professional engineer and used to design and construct a protective system or create a safe working environment in an excavation.

GENERAL

Surface encumbrances that are located so as to create a hazard to employees shall be removed or supported as necessary to safeguard employees.

Underground utilities such as water, sewer, telephone, fuel, electric, and others shall be determined prior to opening an excavation.

Means of egress from an excavation or trench such as a stairway, ladder, ramp or other safe means of egress shall be located so as to require no more than 25 feet of lateral travel for employees working in the excavation or trench.

Employees exposed to vehicular traffic shall wear warning vests of high-visible reflective material.

Employees shall not be permitted to perform work within the swing radius of excavators or other equipment which could make contact with an employee.

During excavation activity, danger signs shall be posted warning employees to stay clear of the swing radius of the machine.

All employees working in an excavation shall wear head protection (hard hats).

No employees shall be permitted underneath loads handled by lifting or digging equipment.

Employees shall be protected from loose rock, or soil that could pose a hazard by falling or rolling from an excavation face or side.

Employees working in excavations shall be protected from cave-ins by an adequate protective system designed in accordance with the OSHA rules and regulations.

Employees entering deep, confined excavations, such as bell-bottom pier holes, shall wear a harness with a safety line attached. This line shall be separate from any line used to handle material. The safety line shall be attended at all times, in case the employee requires rescue.

Smoking inside an excavation is prohibited.

Employees may not work in excavations with accumulated water, unless specific steps are taken to protect from the accumulation hazard.

Materials or equipment shall be placed or stored closer than 2 feet from the edge of the excavation unless the material is secured by restraining devices sufficient to prevent the material from falling into the excavation.

Appropriate eye protection shall be worn when machines or operations present potential eye or face injuries.

All excavations that are deeper than 20 feet shall be designed by a professional engineer.

Where employees or equipment are permitted to cross over excavations, walkways or bridges standard guardrail or fall protection shall be used.

Employees shall be required to stand away from any vehicle being loaded or unloaded to avoid being struck by any spillage or falling materials.

Atmospheric monitoring shall be conducted in excavations where a hazardous atmosphere exists, in oxygen deficient atmospheres (less than 19.5% oxygen) or any time a hazardous atmosphere is suspected to exist within the excavation. Employees shall not be permitted to enter an excavation where a hazardous atmosphere or oxygen deficient atmosphere exists until additional and appropriate precautions have been taken to prevent employee exposure to the hazard. Additional precautions include providing proper respiratory protection or forced ventilation of the excavation. Anytime the atmosphere in an excavation requires that controls are used to reduce the level of atmospheric contaminants to acceptable levels, continuous air monitoring will be performed by the Competent Person using a properly calibrated gas monitor.

Forced ventilation or other effective means shall be used to prevent employee exposure to an atmosphere containing a flammable gas in excess of 10 percent of the lower flammability limit of the gas.

Emergency rescue equipment shall be readily available where hazardous atmospheric conditions exist or may develop during work in an excavation.

No employees shall be permitted to work within a trench underneath heavy equipment.

A warning system shall be used when mobile equipment is operated adjacent to the edge of an excavation if the operator does not have a clear and direct view of the edge of the excavation. Warning systems shall consist of barricades, hand or mechanical signals, or stop logs. If possible, the grade should be away from the excavation.

Employees shall not be permitted to work above other employees on the faces of sloped or benched systems except when employees at the lower levels are protected from the hazard of falling, rolling, or sliding material or equipment.

Utilities must be notified before any work is done within 10 feet of a high voltage line.

COMPETENT PERSON DESIGNATION

Before an employee can be designated as a Competent Person, the employee must demonstrate that he or she possesses the necessary knowledge and experience in the area of excavations. The candidate must be knowledgeable of the requirements set forth in 29 CFR 1926 Subpart P Excavations. The candidate shall be evaluated by an E Light supervisor prior to being designated as a Competent Person. This evaluation shall be documented and documentation shall be sent to the E Light Education and Loss Prevention Coordinator to be kept on file.

A Competent Person designation form must be signed by the candidate and the Site Superintendent or Construction Manager.

INSPECTIONS

An E Light designated Competent Person must conduct daily inspections of excavations, the adjacent areas, and any protective systems used. The purpose of the inspection is to look for evidence of any situation that could result in a possible cave-in, or other hazardous conditions.

See Inspection Checklist for Classification:

Inspections should be conducted prior to the start of work and as needed throughout the shift. Inspections shall also be conducted after hazard increasing occurrences such as rainstorms.

In the event the supervisor the competent person or any exposed employee finds evidence of a situation that could result in a possible cave-in, indication of failure of a protective system, hazardous atmosphere or any other hazardous condition, exposed employees shall be removed from the hazardous area until the necessary precautions have been taken to ensure their safety.

The site Superintendent shall conduct a weekly safety inspection which shall include excavations and excavation work being performed on site.

TRAINING

The Site Construction Manager or Superintendent is responsible to arrange training for affected employees on the requirements of this program. Training shall be conducted by the Site

Construction Manager, Site Superintendent, or E Light Safety representative.

PRE-WORK SITE INSPECTIONS

Prior to excavation the Site Construction Manager or Superintendent shall conduct a site inspection and assessment to determine if any site-specific safety measures must be taken prior to the excavation activity.

UNDERGROUND UTILITIES

The location of sewers, telephone, fuel, electric, water lines, or any other underground installations that may be encountered during excavation work shall be determined and marked prior to opening an excavation.

The Site Construction Manager or Superintendent shall make arrangements with all appropriate utility agencies for the protection, removal, shutdown, or relocation of underground utilities.

BARRICADES AND WALKWAYS

Barricades, walkways, and postings shall be provided as necessary for the protection of employees prior to the start of excavation.

Walkways or bridges shall be provided where employees are permitted to cross over excavations. Guardrails shall be provided where walkways, accessible to on-site project personnel, are 6 feet or more above lower levels.

For guidance on the requirements for guardrails and toe boards, employees will refer to E Light's Fall Protection Program.

Guardrails, fences, or barricades shall be provided around excavations adjacent to walkways, driveways and other pedestrian or vehicle thoroughfares.

NOTE: For protective systems, soil classifications, and other specific details about excavations reference 29 CFR 1926 Subpart P.

APPENDIX FOR SLOPING AND BENCHING FOLLOWS:

SLOPING, SHIELDING AND BENCHING

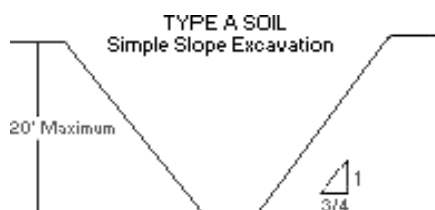

Figure 1 – Normal Sloping Configuration for a “type A soil” open over 24 hours.

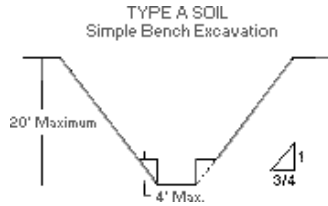

Figure 2 – Normal Sloping Configuration for a “type A soil” open over 24 hours with a bench.

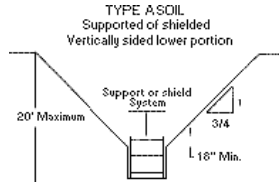

Figure 3 – Normal Sloping Configuration for a “type A soil” open over 24 hours with a trench box.

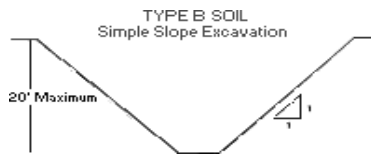

Figure 4 - Normal Sloping configuration for a “type B soil”.

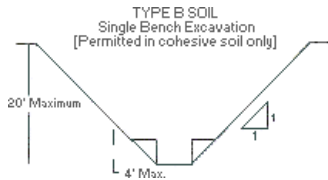

Figure 5 – Normal Sloping Configuration for a “type B soil” with simple bench.

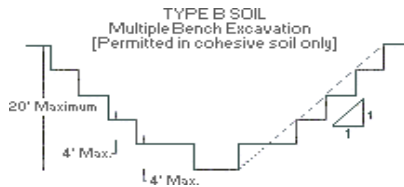

Figure 6 - Benching System for a “type B soil”.

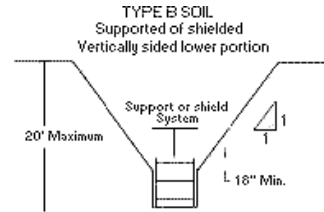

Figure 7 – Normal Sloping Configuration for a “type B soil” with a trench box.

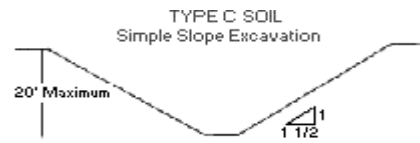

Figure 8 – Normal Sloping Configuration for a “type C soil”.

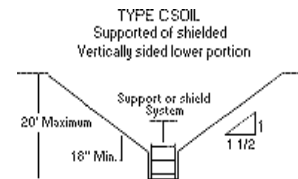
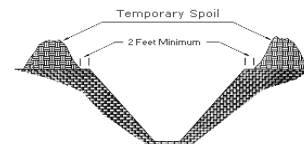
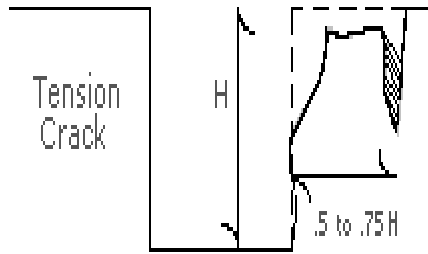

Figure 9 – Normal Sloping Configuration for a “type C soil” with a trench box.



Spoils Management System Must be at least 2 feet from edge of excavation.

COMMON Hazards Found in Excavations



Tension Crack Resulting in a Cave-in.

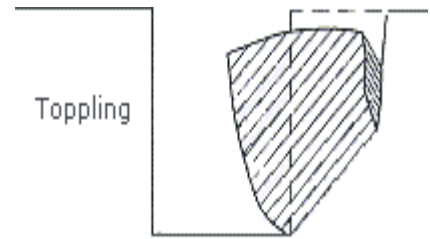

Trench Wall Toppling into Excavation.

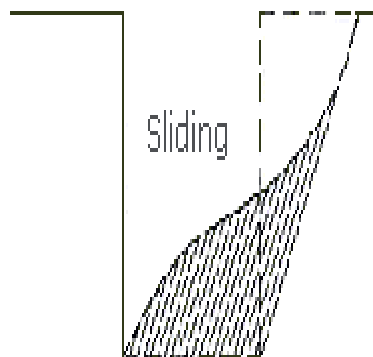

Sliding Material resulting in a Cave-in.

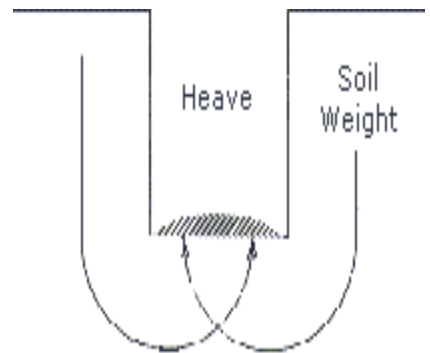

Material Heaving into Trench from Bottom.

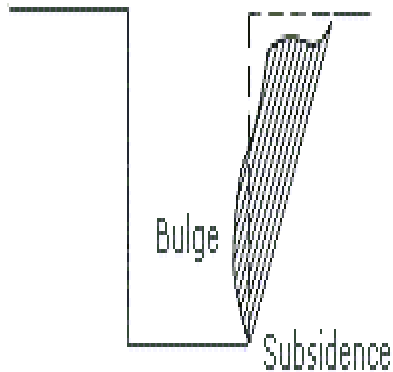

Trench Wall Bulging and can result in a Cave-in.

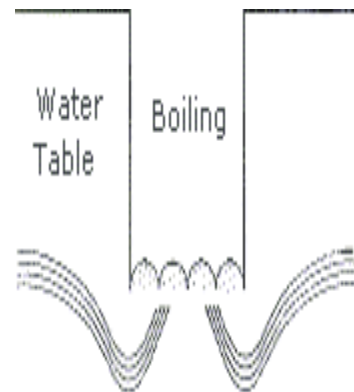

Water Entering Trench from Water.

COMMON PROTECTIVE SYSTEMS

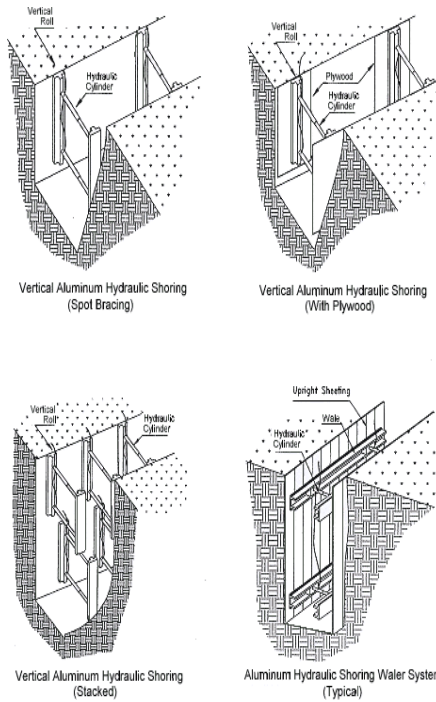

**Aluminum Hydraulic Protective Systems and in place for trenches that can't be sloped,
 Reminder you must use at least 3 shores minimum!
 Two used to create work area and one for egress.**

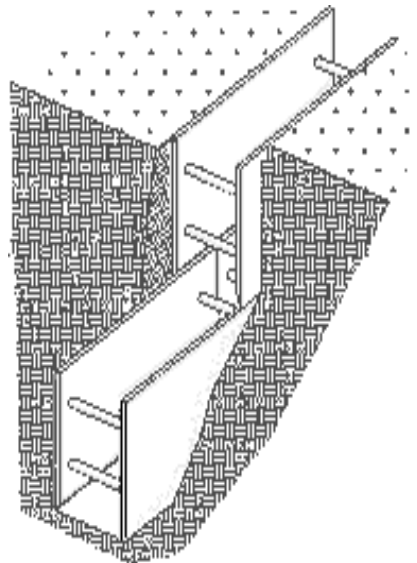

Trench Boxes Stacked and in place for trenches that can't be sloped

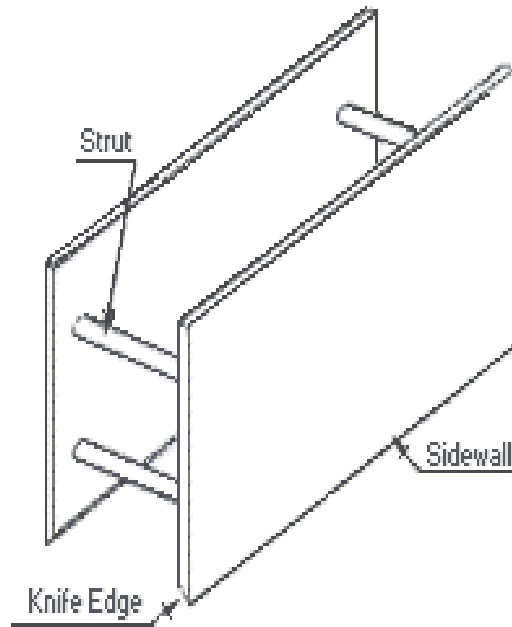

Trench Box Parts

Each Box must be inspected prior to beginning work in them.

Inspect the above for cracks, look for damaged weld joints or weakened areas.

Some have ladders built in them inspect the ladders to ensure they are safe for use.

Excavation of material to a level no greater than 2 feet below the bottom of the members of a support system shall be permitted unless the system is designed to resist the forces calculated for the full depth of the trench.

Gunite is another approved method of protection, normally contracts out the work to be performed and dries relatively quickly. In many cases much less expensive than renting trench boxes or shielding systems. Gunite is a sprayed-on cement type product that is sprayed on the sides of the excavation, sometimes it is sprayed over a support system such as pins, wire and netting.

EXCAVATION INSPECTION REPORT

| | | | |
|-------------------|-----------|----------|--|
| COMPETENT PERSON: | | DATE: | |
| JOB: | LOCATION: | WEATHER: | |

1. VISUAL TEST: (NOTE: ONE VISUAL AND ONE MANUAL TEST ARE REQUIRED)

| | | | | | |
|--|-----|----|---|-----|----|
| TRENCH OR EXCAVATION INSPECTION (REQUIRED DAILY) | | | SOIL IS: COHESIVE _____ GRANULAR _____ CLAY _____ | | |
| TRENCH IS: | YES | NO | SOIL IS: | | |
| SUBJECT TO VIBRATION | | | MOIST | YES | NO |
| FISSURED OR CRACKS ARE PRESENT | | | DRY | YES | NO |
| CAVED-IN | | | A YES ANSWER BELOW MEANS THE SOIL CAN NOT BE A TYPE A SOIL. □ | | |
| LAYERED | | | | | |
| SOIL EXHIBITS: | | | WET | YES | NO |
| PRIOR EXCAVATION | | | SATURATED | YES | NO |
| EXCAVATED SOIL CRUMBLES EASY | | | SUBMERGED | YES | NO |
| A YES ANSWER ABOVE MEANS THE SOIL CANNOT BE A "TYPE A SOIL." | | | LEFT BLANK | | |

**2. SOIL CLASSIFICATION:
MANUAL TEST**

| | | | |
|---|-----------------|----|-------------------------------------|
| Thumb penetration test: Thumb can penetrate less than ¼ inch or less Type A soil. | ¼ or less: Yes | No | If yes Type A (¾ to 1) 53 degrees |
| Thumb penetrates from ¼ to 1 inch Type B soil. | ¼ to 1 inch Yes | No | If yes Type B (1 to 1) 45 degrees |
| Thumb penetrates an inch or more type C soil | Over 1 inch Yes | No | If yes Type C (1 ½ to 1) 34 degrees |

| | | |
|---|---------------------|--|
| SOIL TYPE: _____ | TRENCH DEPTH: _____ | PROTECTION: TRENCH BOX _____ SLOPE _____ SLOPE < _____ |
| FOR SPECIAL CONDITIONS SUCH AS EXCAVATIONS LESS THAN 12 FT DEEP, SEE 29 CFR 1926.650 TABLE B-1 A SHORT-TERM MAXIMUM ALLOWABLE SLOPE OF ½ TO 1 (63 DEGREES) IS ALLOWED IN TYPE A SOIL THAT IS 12 FT OR LESS IN DEPTH. | | |

3. GENERAL TRENCH SAFETY:

| CHECKLIST | YES | NO | IF YES: DO |
|---|-----|----|---|
| EXISTING UTILITIES ARE PRESENT | | | CALL 811 or go to http://call811.com/811-your-state |
| THERE IS A POTENTIAL HAZARDOUS ATMOSPHERE | | | CALL SAFETY MANAGER AND TEST AIR BEFORE ENTERING |
| THE TRENCHES ARE MORE THAN FOUR (4) FEET DEEP | | | HAVE RAMPS/LADDERS WITHIN 25 FEET OF WORK AREA |
| THE TRENCHES ARE DEEPER THAT FIVE (5) FEET DEEP | | | SLOPE, SHIELD, OR SHORE THE EXCAVATION |
| THE TRENCHES ARE DEEPER THAN TWENTY (20) FEET DEEP | | | HAVE TRENCH DESIGNED BY REGISTERED PROFESSIONAL ENGINEER |
| THE SPOIL PILES ARE WITHIN TWO (2) FEET FROM THE EDGE OF THE TRENCH | | | MOVE SPOILS, MATERIALS, AND EQUIPMENT BACK TWO (2) FEET |
| THERE ARE BUILDINGS OR OTHER STRUCTURES NEAR THE TRENCH | | | HAVE AN ENGINEER CHECK AND DOCUMENT THEIR STABILITY |
| ELECTRIC PUMPS ARE USED FOR DEWATERING | | | MAKE SURE THEY ARE PROPERLY WIRED AND GROUNDED |
| TRENCH BOXES, SHORING, OR SHIELDS ARE BENT OR BROKEN | | | REPLACE EQUIPMENT AS REQUIRED |
| TRENCH BOXES ARE FLUSH WITH TOP OF TRENCH | | | BOXES MUST EXTEND ABOVE THE TRENCH A MINIMUM OF EIGHTEEN (18) INCHES |
| IS THERE A TRENCH BOX CERTIFICATE ON SITE | | | WHERE: |
| ARE BARRICADES, TAPE, OR SIGNS NEEDED | | | WHERE: |
| ARE WORKERS SUBJECT TO VEHICLE TRAFFIC | | | SUPPLY SAFETY VEST AND BARRICADES IF NECESSARY |
| SOMEONE IS WORKING IN A TRENCH ALONE | | | HAVE A TOP MAN PRESENT AT ALL TIMES |

VISUAL AND MANUAL TESTS MUST BE MADE DAILY PRIOR TO START, OR WHEN CONDITIONS CHANGE DURING THE DAY

Inspection Checklist

Date: _____ Time: _____ Location: _____ Competent Person: _____

| | | | | | |
|----------------------------------|-------------------|----|-------------------------------|-----|----|
| Job Site Description | | | | | |
| Area Congested | YES | NO | Right of Way & Clearance O.K. | YES | NO |
| Trench Depth: _____ | Width: _____ | | Length: _____ | | |
| Crossing Trench or Excavation | Power Lines _____ | | Roads _____ / Alley _____ | | |
| Parallel to Trench or Excavation | Power Lines _____ | | Roads _____ / Alley _____ | | |
| Overhead Power lines | YES | NO | Water in Excavation Trench | YES | NO |
| Utilities Companies Notified | YES | NO | Utilities Marked or Staked | YES | NO |
| Comments: _____ | | | | | |

| | | | | | |
|---------------------------------------|---------------------------|-----------------|-----------------|-------------------------|----|
| TRENCH / EXCAVATION INSPECTION | | | | | |
| Soil Type | A | B | C | Spoil Pile Angle: _____ | |
| Slop Angle: _____ | Benching Angle: _____ | | | | |
| Manual Soil Tests | (Circle what applies) | | | | |
| Plasticity & Pat test- | <i>Fissured</i> | <i>Cohesive</i> | <i>Granular</i> | Is Excavation less | |
| Dry Strength | <i>Fissured</i> | <i>Cohesive</i> | <i>Granular</i> | then 5' in depth | |
| Drying | <i>Fissured</i> | <i>Cohesive</i> | <i>Granular</i> | YES | No |
| Thumb Penetration- | Type A _____ 1/4" or less | | | Has the Soil been | |
| | Type B _____ 1/4" to 1" | | | previously disturbed | |
| | Type C _____ 1" or more | | | YES Type One Less | |
| Pocket Pentrometer Results | _____ | | | NO Same Class | |

| | | |
|---|---|----------------------------|
| Visual Tests | Cohesive | Granular |
| | Type A or B | Type C |
| Spoil Pile | Remains in Clumps: _____ | Breaks up easily _____ |
| | Fine Grained Clay _____ | Coarse Grained _____ |
| Excavation Sides | Stands Vertical _____ | Silt, Sand or Gravel _____ |
| | for over 2 hrs | Sloughs in Trench _____ |
| | Fine Grained Clay _____ | Coarse Grained _____ |
| | | Silt, Sand or Gravel _____ |
| Fissures - Excavation Side (Cracks or Spalls) | _____ | |
| Fissures - Top of Excavation (Cracks or Openings) | _____ | |
| Soil Layers Slope into Excavation 4:1 or Steeper | _____ | |
| Rock Layers above Soil Layer | _____ | |
| Vibration Sources | YES | NO |
| Unusual Circumstances: | If yes downgrade one class or Type: _____ | |
| Type of Protection Used | <i>Shoring</i> | <i>Benching</i> |
| | <i>Sloping</i> | <i>Option</i> _____ |
| Spoil Pile back more than two feet? | YES | NO Distance _____ |
| Is there a potential for a Hazardous Atmosphere, | YES | NO Precautions taken |
| if Yes: | _____ | |

EMPLOYEE AND PUBLIC SAFETY

| | | |
|--|--------------------|--------|
| Employees within 25 ft of egress (Lateral travel) | YES | NO |
| Ramps | YES | NO |
| Emergency Equipment | YES | NO |
| | Water Removal | YES NO |
| Traffic Control | YES | NO |
| | Barricaded | YES NO |
| Air Testing Equipment Needed | YES | NO |
| | Weekend Protection | YES NO |
| CLASS OF SOIL: (CIRCLE ONE) SOLID ROCK TYPE A TYPE B TYPE C | | |